



# U3A Intermediate Bridge 2025-26



While waiting for 10am – Week 14

We did BBO's Bridgmaster practice hand "Advanced (level 3) Hand #A1", with the group choosing the moves.



# U3A Intermediate Bridge 2025-26



Week 14 Welcome

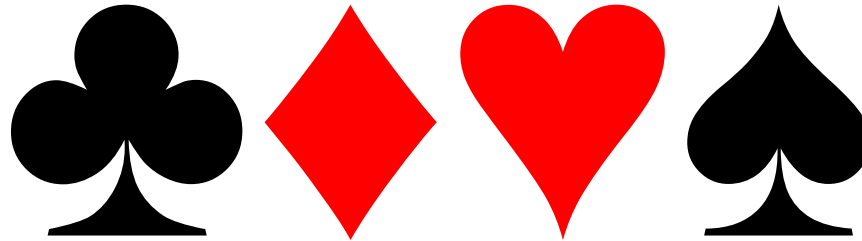

Steve Bailey



# U3A Intermediate Bridge 2023-24



## Week 14 Set hands

This week we are reviewing a couple of set hands from previous weeks.

The first is set hand 3 from week 12.

Board=3                      Dealer={S}      Vulnerability={EW}

NS	EW	Contract	Dcl	OL	Trk	NS#	EW#	NS%	EW%
1	9	3Dx+2	S	JC	11	670	-	66.7%	33.3%
2	10	3H-1	N	QC	8	-	50	0%	100%
5	13	5H+2	N	QC	13	510	-	33.3%	66.7%
Ref		6H=	N	JS	12	980	-	100%	0%

I have chosen this as a deal to study as no table reached the reference contract. However one pair did make one more trick than the reference - good.

We will be reviewing the auction, the opening lead and the play.



# U3A Intermediate Bridge 2025-26



## Week 14 Set Hand wk12#3

Dir={S} Vul={EW}

♠ 32  
♥ AK432  
♦ AQJ  
♣ A32

♠ A54  
♥ 76  
♦ 6  
♣ JT98765

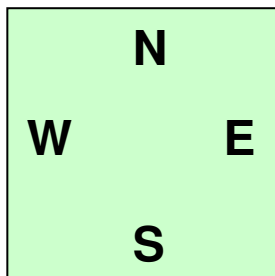

♠ KQ  
♥ JT98  
♦ KT987  
♣ K4

♠ JT9876  
♥ Q5  
♦ 5432  
♣ Q

<b>S</b>	<b>W</b>	<b>N</b>	<b>E</b>
?			

This is the whole deal.

As we discuss the auction, I will select just the hand making a bid.

{S} is dealer.

What do we do first?



# U3A Intermediate Bridge 2025-26



## Week 14 Set Hand wk12#3

Dir={S} Vul={EW}

<b>S</b>	<b>W</b>	<b>N</b>	<b>E</b>
?			

We evaluate the hand.

What do you reckon?

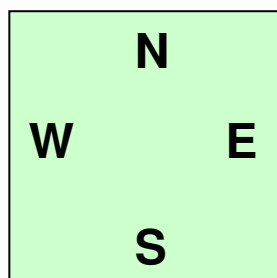

♠ KQ  
♥ JT98  
♦ KT987  
♣ K4



# U3A Intermediate Bridge 2025-26



## Week 14 Set Hand wk12#3

Dir={S} Vul={EW}

<b>S</b>	<b>W</b>	<b>N</b>	<b>E</b>
?			

We evaluate the hand.

It is 5422 in shape. The L5 is a minor suit, so we are more interested in NT contracts than in suit contracts. If {S} has the relevant strength, D will be bid.

hcp = KQJKK = 12hcp.

And?

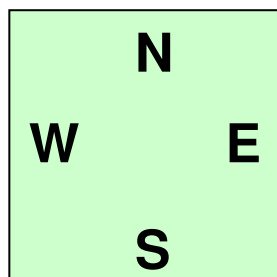

- ♠ KQ
- ♥ JT98
- ♦ KT987
- ♣ K4



# U3A Intermediate Bridge 2025-26



## Week 14 Set Hand wk12#3

Dir={S} Vul={EW}

<b>S</b>	<b>W</b>	<b>N</b>	<b>E</b>
?			

And then we do a more detailed hand evaluation using "hltf aiu(s)".

hcp	12
length	
tens	
flat	
acelessness	
isolated	
unguarded	
(shortage)	

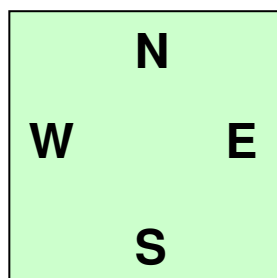

5422
12hcp

♠ KQ  
 ♥ JT98  
 ♦ KT987  
 ♣ K4



# U3A Intermediate Bridge 2025-26



## Week 14 Set Hand wk12#3

Dir={S} Vul={EW}

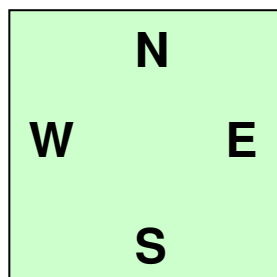

5422
12hcp
13Pts

♠ KQ  
 ♥ JT98  
 ♦ KT987  
 ♣ K4

l+1; t+1;  
 a-1;

S            W            N            E  
 ?

And then we do a more detailed hand evaluation using "hltf aiu(s)".

hcp	12
length	+1(L5D, to K)
tens	+1(10H,10D)
flat	0(N/A)
acelessness	-1(No A)
isolated	0(Only 1, KC)
unguarded (shortage)	0(N/A) <i>Not yet</i>

12+1+1-1 = 13Pts.

Is that enough to open the bidding? Yes. So {S} bids...



# U3A Intermediate Bridge 2023-24



## Week 14 Hand Evaluation

This slide summarises my (flawed) hand evaluation scheme.

If anyone comes up with a SIMPLE way of improving it, please let me know.

### hltf aiu(s)

h	hcp	A=4 K=3 Q=2 J=1
l	length	L5+Suit headed by A/K/Q/JT/J9/T9 : Add 1 per card over L4 L5+Suit headed by J/T/9 : Add ½ per card over L4 L5+Suit headed by 8/7/6 : Add 0
t	tens	10 is honour if with A/K/Q/J/9. Add ½ for first 2 honour tens
f	flat	Subtract 1 if 4333 shape (not ruffable, not length winners)
a	acelessness	Subtract 1 if no A
l	isolated	Subtract 1 if single honours (incl 10s) in 3+ suits. Not AAA
u	unguarded	Subtract half value K=1½ Q=1 J=½ if singleton honour Restore half later if partner bids suit naturally
(s)	(shortage)	Only applies after 8+card fit found for shortest 2 suits. 'Owner' of fit suit : Add '123' L2=1 L1=2 L0=3 'Partner' of fit suit : Add '135' L2=1 L1=3 L0=5

I refer to hcp as hcp and to these as 'evaluated points' (Pts).

Joint Points are referred to as JPts.



# U3A Intermediate Bridge 2025-26



## Week 14 Set Hand wk12#3

Dir={S} Vul={EW}

<b>S</b>	<b>W</b>	<b>N</b>	<b>E</b>
1D			

So {S} bids one of their longest suit, D.

The bid shows  
12..19Pts, L4+D.

{S} actually has  
(12hcp, 13Pts, L5D.)

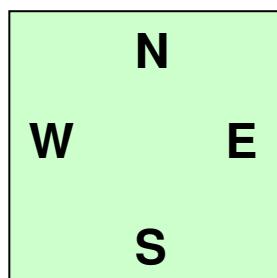

5422
12hcp
13Pts

♠ KQ  
♥ JT98  
♦ KT987  
♣ K4

l+1; t+1;  
a-1;



# U3A Intermediate Bridge 2025-26



## Week 14 Set Hand wk12#3

Dir={S} Vul={EW}

7321  
5hcp

♠ A54  
♥ 76  
♦ 6  
♣ JT98765

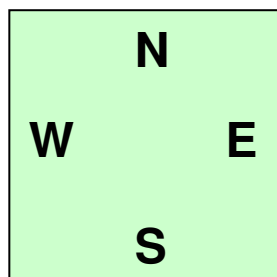

<b>S</b>	<b>W</b>	<b>N</b>	<b>E</b>
1D	?		

{W} now. Again we evaluate, but {W}'s hand is trickier.

Shape is 7321.

hcp = AJ = 5hcp.

Then the fuller evaluation using "hltf aiu(s)".





# U3A Intermediate Bridge 2025-26



## Week 14 Set Hand wk12#3

Dir={S} Vul={EW}

l+3;  
t+1/2;

7321  
5hcp  
8 1/2 Pts

♠ A54  
♥ 76  
♦ 6  
♣ JT98765

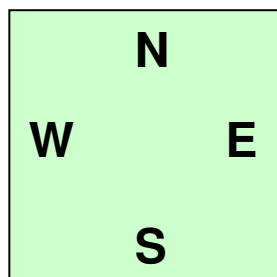

<b>S</b>	<b>W</b>	<b>N</b>	<b>E</b>
1D	?		

A fuller evaluation using "hltf aiu(s)".

hcp	5
length	+3(L7C, to JT)
tens	+1/2(JC)
flat	0(N/A)
acelessness	0(AS)
isolated	0(Only 1, AS)
unguarded (shortage)	0(N/A) <i>Not yet</i>

5+3+1/2 = 8 1/2 Pts.



# U3A Intermediate Bridge 2025-26



## Week 14 Set Hand wk12#3

Dir={S} Vul={EW}

l+3;

t+1/2;

7321  
5hcp  
8½Pts

♠ A54  
♥ 76  
♦ 6  
♣ JT98765

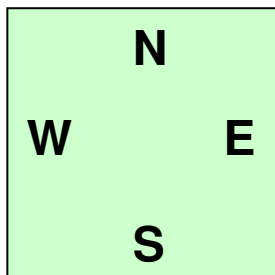

S	W	N	E
1D	?		

Can {W} bid?

Despite the L1D, not a TOD, since S & H aren't good enough.

Overcall? Maybe.

You need 11+Pts, L5+Suit, 2+Suit honours, SQOT=8+ to overcall over 1D with 2C.

So the simple answer is "No". But the more in depth answer is "Is there a reason to make a sacrificial pre-emptive overcall", #3C? I'm not sure there is over JUST 1D. To do so is aggressive. I would want better C honours.



# U3A Intermediate Bridge 2025-26



## Week 14 Set Hand wk12#3

Dir={S} Vul={EW}

l+3;  
t+1/2;

7321  
5hcp  
8½Pts

♠ A54  
♥ 76  
♦ 6  
♣ JT98765

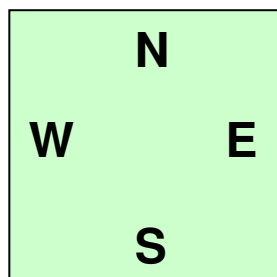

{W} is too weak to overcall with 2C. I think that if you do decide to overcall, the the pre-emptive #3C has to be the bid, getting in the way more, **but I vote "Pass"**.

S	W	N	E
1D	?		

Can {W} bid?

Despite the L1D, not a TOD, since S & H aren't good enough.

Overcall? Maybe.

You need 11+Pts, L5+Suit, 2+Suit honours, SQOT=8+ to overcall over 1D with 2C.

So the simple answer is "No". But the more in depth answer is "Is there a reason to make a sacrificial pre-emptive overcall", #3C? I'm not sure there is over JUST 1D. To do so is aggressive. I would want better C honours.



# U3A Intermediate Bridge 2025-26



## Week 14 Set Hand wk12#3

Dir={S} Vul={EW}

♠ 32	5332
♥ AK432	18hcp
♦ AQJ	
♣ A32	

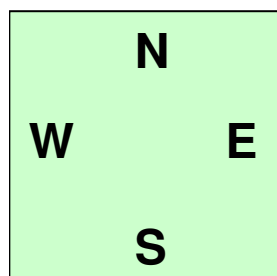

<b>S</b>	<b>W</b>	<b>N</b>	<b>E</b>
1D	P	?	

What about {N}?

Shape is 5332.

hcp = AKAQJA = 18hcp.

Then a fuller evaluation using "hltf aiu(s)".



# U3A Intermediate Bridge 2025-26



## Week 14 Set Hand wk12#3

Dir={S} Vul={EW}

♠ 32	5332
♥ AK432	18hcp
♦ AQJ	
♣ A32	

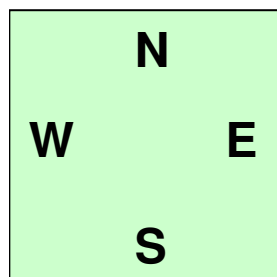

<b>S</b>	<b>W</b>	<b>N</b>	<b>E</b>
1D	P	?	

What about {N}?

Then a fuller evaluation using "hltf aiu(s)".

hcp 18

length

tens

flat

acelessness

isolated

unguarded

(shortage)



# U3A Intermediate Bridge 2025-26



## Week 14 Set Hand wk12#3

Dir={S} Vul={EW}

♠ 32  
♥ AK432  
♦ AQJ  
♣ A32

5332
18hcp
19Pts

l+1;

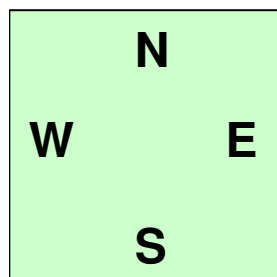

<b>S</b>	<b>W</b>	<b>N</b>	<b>E</b>
1D	P	?	

What about {N}?

Then a fuller evaluation using "hltf aiu(s)".

hcp	18
length	+1(L5H, to A)
tens	0(No 10s)
flat	0(No)
acelessness	0(AH,AD,AC)
isolated	0(Only 1, AC)
unguarded	0(N/A)
(shortage)	<i>Not yet</i>

18+1 = 19Pts.



# U3A Intermediate Bridge 2025-26



## Week 14 Set Hand wk12#3

Dir={S} Vul={EW}

♠ 32  
♥ AK432  
♦ AQJ  
♣ A32

5332
18hcp
19Pts

l+1;

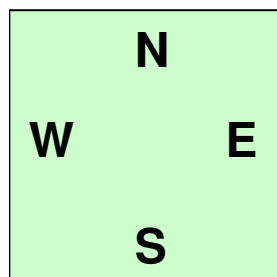

<b>S</b>	<b>W</b>	<b>N</b>	<b>E</b>
1D	P	#2H	

What about {N}?

With 19Pts, knows game is on, but not which game.

12..19Pts + 19Pts = 31..38 JPts.  
A slam may be on.

Start by showing longest suit which is also a major.

With 16+Pts, do a "Jump Shift" (jump bid a new suit to show 16+Pts and L5+Suit with K+).

Bid #2H.



# U3A Intermediate Bridge 2025-26



## Week 14 Jump Shift

I am not sure if we have ever covered a **Jump Shift**. Traditionally this is a strong bid, *but some also use modern weak variants*.

A strong jump shift is a response to an opening bid of **1Suit** with a **jump** to a **new suit** at the 2-level or 3-level (Eg 1D : #2H or 1S : #3C). It shows 16+Pts and either good support for Opener's suit or a self-supporting suit of your own that is good for Game, even partnering just a singleton. Slam is likely. The bidder should have L5+NewSuit that contains at least 5hcp. It is forcing to Game.

Opener then makes his planned rebid, 1 level higher than expected due to the JUMP in jump shift, whether NTs, a second suit or the first suit rebid.

Then your rebid shows either support for Opener's suit or is a rebid of the new suit. It also promises an L5+suit headed by at least K. The suit REBID by the jump shifter defines the trump suit, no argument, unless Opener's rebid makes jump shifter's rebid redundant.



# U3A Intermediate Bridge 2025-26



## Week 14 Set Hand wk12#3

Dir={S} Vul={EW}

S	W	N	E
1D	P	#2H	?

And {E}?

The shape is 6421, with major L6S, but only to JT.

hcp = JQQ = 5hcp.

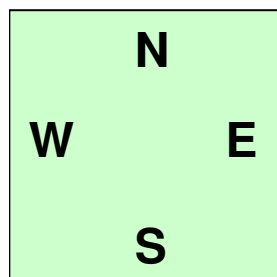

♠ JT9876  
 ♥ Q5  
 ♦ 5432  
 ♣ Q

6421
5hcp



# U3A Intermediate Bridge 2025-26



## Week 14 Set Hand wk12#3

Dir={S} Vul={EW}

<b>S</b>	<b>W</b>	<b>N</b>	<b>E</b>
1D	P	#2H	?

Evaluating {E}.

hcp 5  
length  
tens  
flat  
acelessness  
isolated  
unguarded  
(shortage)

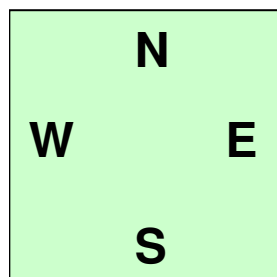

♠ JT9876  
♥ Q5  
♦ 5432  
♣ Q

6421
5hcp



# U3A Intermediate Bridge 2025-26



## Week 14 Set Hand wk12#3

Dir={S} Vul={EW}

<b>S</b>	<b>W</b>	<b>N</b>	<b>E</b>
1D	P	#2H	?

Evaluating {E}.

hcp	5
length	+2(L6S, JT)
tens	+1/2(10S)
flat	0(N/A)
acelessness	-1(No A)
isolated	0(Only 2, QH, QC)
unguarded (shortage)	-1(QC) <i>Not yet</i>

$$5+2+1/2-1-1 = 5\frac{1}{2}\text{Pts.}$$

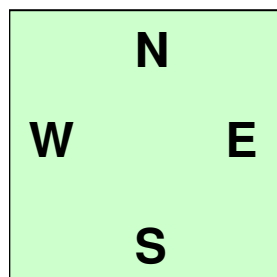

♠ JT9876  
♥ Q5  
♦ 5432  
♣ Q

6421
5hcp
5½Pts

l+2; t+1/2;  
a-1; u-1;



# U3A Intermediate Bridge 2025-26



## Week 14 Set Hand wk12#3

Dir={S} Vul={EW}

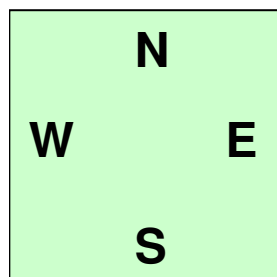

♠ JT9876  
 ♥ Q5  
 ♦ 5432  
 ♣ Q

6421
5hcp
5½Pts

l+2; t+½;  
 a-1; u-1;

<b>S</b>	<b>W</b>	<b>N</b>	<b>E</b>
1D	P	#2H	?

Evaluating {E}.

hcp	5
length	+2(L6S, JT)
tens	+½(10S)
flat	0(N/A)
acelessness	-1(No A)
isolated	0(Only 2, QH, QC)
unguarded (shortage)	-1(QC) Not yet

5+2+½-1-1 = 5½Pts.

Bid?



# U3A Intermediate Bridge 2025-26



## Week 14 Set Hand wk12#3

Dir={S} Vul={EW}

<b>S</b>	<b>W</b>	<b>N</b>	<b>E</b>
1D	P	#2H	P

5+2+1/2-1-1 = 5 1/2 Pts.

Bid?

Far too weak.

Pass.

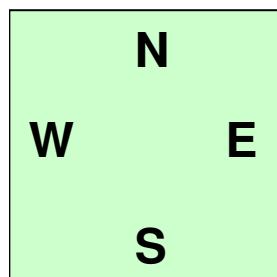

♠ JT9876  
 ♥ Q5  
 ♦ 5432  
 ♣ Q

6421
5hcp
5 1/2 Pts

l+2; t+1/2;  
 a-1; u-1;



# U3A Intermediate Bridge 2025-26



## Week 14 Set Hand wk12#3

Dlr={S} Vul={EW}

<b>S</b>	<b>W</b>	<b>N</b>	<b>E</b>
1D	P	#2H	P
?			

Does {S} need to change his 13Pts evaluation as a result of the bids so far?

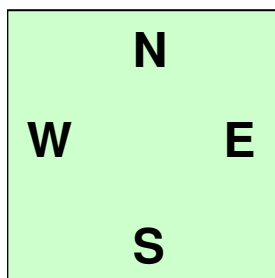

5422
12hcp
13Pts

♠ KQ  
 ♥ JT98  
 ♦ KT987  
 ♣ K4

l+1; t+1;  
a-1;



# U3A Intermediate Bridge 2025-26



## Week 14 Set Hand wk12#3

Dir={S} Vul={EW}

<b>S</b>	<b>W</b>	<b>N</b>	<b>E</b>
1D	P	#2H	P
?			

Does {S} need to change his 13Pts evaluation as a result of the bids so far?

YES. L5+H + L4H = 9+ \* H, a fit.

So Re-eval:

13Pts + 1Pt(L2S,135) +  
1Pt(L2C,135) = 15Pts.

(It is 135 because H are "owned" by {N}).

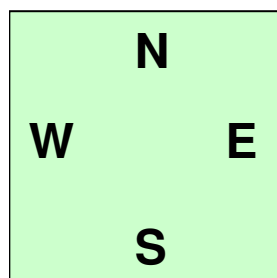

5422
12hcp
15Pts

♠ KQ  
♥ JT98  
♦ KT987  
♣ K4

l+1; t+1;  
a-1; s+2;



# U3A Intermediate Bridge 2025-26



## Week 14 Set Hand wk12#3

Dir={S} Vul={EW}

<b>S</b>	<b>W</b>	<b>N</b>	<b>E</b>
1D	P	#2H	P
?			

13Pts + 1Pt(L2S,135) +  
1Pt(L2C,135) = 15Pts.

Jointly 16+Pts + 15Pts  
= 31+ JPts. Slam region.

Also using LTC:

S1 (S:Q)  
H3 (H:JT9)  
D2 (D:T9)  
C1 (C:4)  
= 7LTs.

This is the standard value for an opening hand.

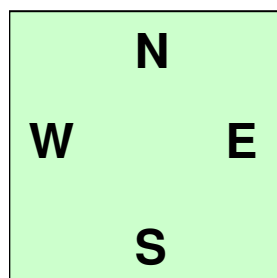

5422
12hcp
15Pts

♠ KQ  
♥ JT98  
♦ KT987  
♣ K4

l+1; t+1;  
a-1; s+2;



# U3A Intermediate Bridge 2025-26



## Week 14 Set Hand wk12#3

Dir={S} Vul={EW}

<b>S</b>	<b>W</b>	<b>N</b>	<b>E</b>
1D	P	#2H	P
3H			

15Pts.

Jointly 31+ JPts.

7LTs (standard value).

How many LTs do we assign to {N} for his jump shift?

Apparently a strong jump shift is assumed to be 6LTs, so we have  $18-7-6 = 5$ , suggesting a 5 level bid.

The 30+ Joint Pts suggest a suited slam may be viable. So investigate this. Show a fit, leaving room to manoeuvre.

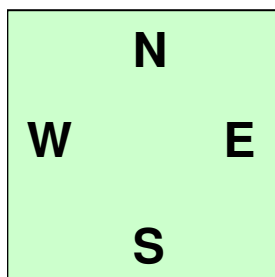

5422
12hcp
15Pts

♠ KQ  
 ♥ JT98  
 ♦ KT987  
 ♣ K4

l+1; t+1;  
a-1; s+2;



# U3A Intermediate Bridge 2025-26



## Week 14 Set Hand wk12#3

Dir={S} Vul={EW}

S	W	N	E
1D	P	#2H	P
3H			

The 3H bid is one which is stronger than the "fast arrival at Game but no further" bid of 4H. It generally agrees a slam is possible and suggests 12..15Pts.

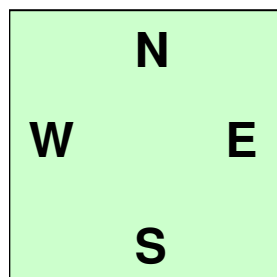

5422
12hcp
15Pts

♠ KQ  
 ♥ JT98  
 ♦ KT987  
 ♣ K4

l+1; t+1;  
a-1; s+2;



# U3A Intermediate Bridge 2025-26



## Week 14 Set Hand wk12#3

Dir={S} Vul={EW}

l+3;  
t+1/2;

7321  
5hcp  
8 1/2 Pts

♠ A54  
♥ 76  
♦ 6  
♣ JT98765

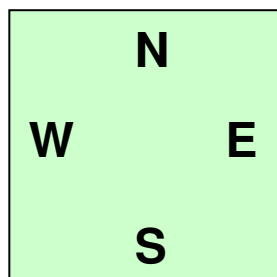

♠ JT9876  
♥ Q5  
♦ 5432  
♣ Q

6421  
5hcp  
5 1/2 Pts

l+2; t+1/2;  
a-1; u-1;

<b>S</b>	<b>W</b>	<b>N</b>	<b>E</b>
1D	P	#2H	P
3H	P		

*From here onwards, I am assuming {EW} just Pass. If you disagree, shout out as we skip over where you would bid.*



# U3A Intermediate Bridge 2025-26



## Week 14 Set Hand wk12#3

Dlr={S} Vul={EW}

♠ 32  
♥ AK432  
♦ AQJ  
♣ A32

5332
18hcp
20Pts

l+1;  
s+1;

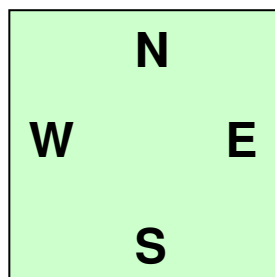

S	W	N	E
1D	P	#2H	P
3H	P	?	

{N} now knows of a H fit and  
Re-evals:

19Pts + 1Pt(L2S,123) = 20Pts.

Jointly 20Pts + 12+Pts = 32+Pts.  
Slam should be investigated.



# U3A Intermediate Bridge 2025-26



## Week 14 Set Hand wk12#3

Dir={S} Vul={EW}

♠ 32  
♥ AK432  
♦ AQJ  
♣ A32

5332
18hcp
20Pts

I+1;  
S+1;

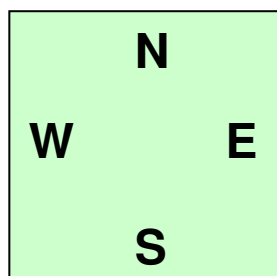

S	W	N	E
1D	P	#2H	P
3H	P	?	

Using LTC:

S2 (S:32)  
H1 (H:4)  
D1 (D:J)  
C2 (C:32) = 6LTs

Assuming 7LTs for opening 1D bid by {S} we get  
 $18-7-6 = 5$ .

This suggests that a slam is NOT on. This seems to be a situation where the LTC doesn't get it right! I am unsure how to manage this. Regardless, continuing with Evaluated Points.



# U3A Intermediate Bridge 2025-26



## Week 14 Set Hand wk12#3

Dir={S} Vul={EW}

♠ 32  
♥ AK432  
♦ AQJ  
♣ A32

5332
18hcp
20Pts

l+1;  
s+1;

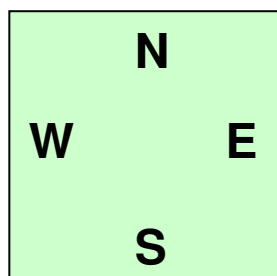

S	W	N	E
1D	P	#2H	P
3H	P	4C	

Anyway, using Joint Points, slam should be investigated further.

{N} has control of H (AH), D (AD) and C (AC), but not of S.

Therefore use Italian Cue Bids to determine if {S} has S control.

Bid next suit up from H, skipping S, so 4C.



# U3A Intermediate Bridge 2025-26



## Week 14 Set Hand wk12#3

Dir={S} Vul={EW}

S	W	N	E
1D	P	#2H	P
3H	P	4C	P
?			

{S} recognises 4C as an Italian Cue Bid.

{S} has control of D (KD), so would like to show that with a 4D bid.

But realises that {N} has skipped over S, showing no control of S. Therefore, does {S} have S control? YES, (KS).

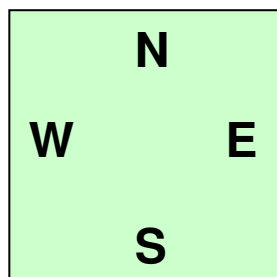

5422
12hcp
15Pts

♠ KQ  
 ♥ JT98  
 ♦ KT987  
 ♣ K4

l+1; t+1;  
 a-1; s+2;



# U3A Intermediate Bridge 2025-26



## Week 14 Set Hand wk12#3

Dir={S} Vul={EW}

S	W	N	E
1D	P	#2H	P
3H	P	4C	P
4D			

But realises that {N} has skipped over S, showing no control of S. Therefore, does {S} have S control?

Yes, (KS).

Therefore bid 4D.

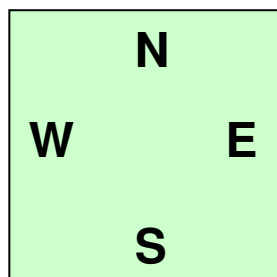

5422
12hcp
15Pts

♠ KQ  
 ♥ JT98  
 ♦ KT987  
 ♣ K4

l+1; t+1;  
 a-1; s+2;



# U3A Intermediate Bridge 2025-26



## Week 14 Set Hand wk12#3

Dir={S} Vul={EW}

♠ 32  
♥ AK432  
♦ AQJ  
♣ A32

5332
18hcp
20Pts

l+1;  
s+1;

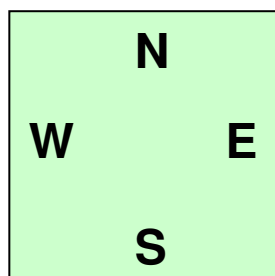

S	W	N	E
1D	P	#2H	P
3H	P	4C	P
4D	P	?	

The 4D bid shows D and S control. So all four suits are controlled.

Is Keycard Blackwood needed?



# U3A Intermediate Bridge 2025-26



## Week 14 Set Hand wk12#3

Dir={S} Vul={EW}

♠ 32  
♥ AK432  
♦ AQJ  
♣ A32

5332
18hcp
20Pts

l+1;  
s+1;

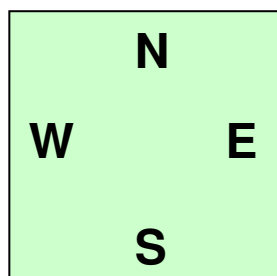

S	W	N	E
1D	P	#2H	P
3H	P	4C	P
4D	P	#6H	

{N} has 4 keycards (AH KH AD AC) and is only missing one (AS). KBw could be used if interested in a grand slam. But a small slam is easier to make, just bid 6H directly.



# U3A Intermediate Bridge 2025-26



## Week 14 Set Hand wk12#3

Dir={S} Vul={EW} 6H by {N}

l+3;  
t+1/2;

7321  
5hcp  
8 1/2 Pts

♠ 32  
♥ AK432  
♦ AQJ  
♣ A32

5332  
18hcp  
20 Pts

l+1;  
s+1;

S	W	N	E
1D	P	#2H	P
3H	P	4C	P
4D	P	#6H	P
P	P		

Then everyone passes.

♠ A54  
♥ 76  
♦ 6  
♣ JT98765

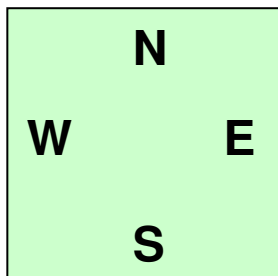

♠ JT9876  
♥ Q5  
♦ 5432  
♣ Q

5422  
12hcp  
15 Pts

♠ KQ  
♥ JT98  
♦ KT987  
♣ K4

6421  
5hcp  
5 1/2 Pts

l+1; t+1;  
a-1; s+2;

l+2; t+1/2;  
a-1; u-1;



# U3A Intermediate Bridge 2025-26



## Week 14 Set Hand wk12#3

Dir={S} Vul={EW} 6H by {N}

S	W	N	E
1D	P	#2H	P
3H	P	4C	P
4D	P	#6H	P
P	P		

The contract is 6H by {N}, so {E} is on opening lead.

What to lead?

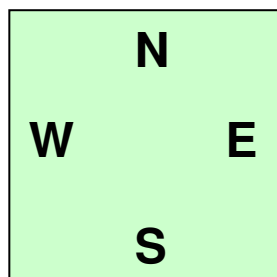

- ♠ JT9876
- ♥ Q5
- ♦ 5432
- ♣ Q



# U3A Intermediate Bridge 2025-26



## Week 14 Set Hand wk12#3

Dir={S} Vul={EW} 6H by {N}

S	W	N	E
1D	P	#2H	P
3H	P	4C	P
4D	P	#6H	P
P	P		

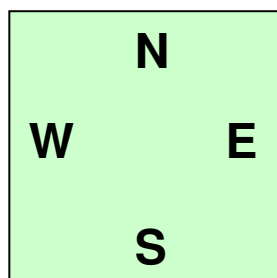

♠ JT9876  
 ♥ Q5  
 ♦ 5432  
 ♣ Q

The source chooses the JS lead, which is the unbid suit.

{E} has two or three sensible choices for an opening lead:

A) Top of an honour headed sequence of 2+ against a suit contract ~ JS

B) A singleton (again against a suit contract) ~ QC

C) Also on occasion a trump may be right (lead low in trumps) ~ 5H



# U3A Intermediate Bridge 2025-26



## Week 14 Set Hand wk12#3

Dir={S} Vul={EW} 6H by {N}

♠ 32  
♥ AK432  
♦ AQJ  
♣ A32

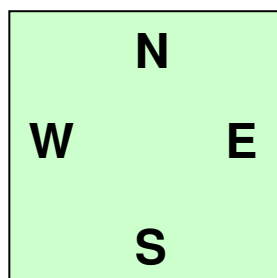

♠ J  
♥  
♦  
♣

♠ KQ  
♥ JT98  
♦ KT987  
♣ K4  
*Dummy*

So now {N} makes a plan with ATTITWDE.

Aim ~

Top Tricks ~

eXtra Tricks ~

Worry about Defence ~

Entries / Execution ~

Despite being one topic of this session's presentation, I observed that some players were keen to play the first card from dummy WITHOUT making a plan first.

That will rarely get a top result.



# U3A Intermediate Bridge 2025-26



## Week 14 Set Hand wk12#3

Dir={S} Vul={EW} 6H by {N}

{N} makes a plan with  
ATTITWDE.

Aim ~ Contract, 12 tricks.

Top Tricks ~ S:-  
H:AK  
D:AKQJT  
C:AK  
= 9 TT

♠ 32  
♥ AK432  
♦ AQJ  
♣ A32

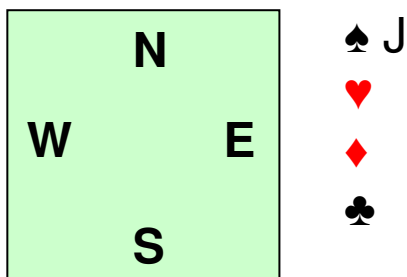

♠ KQ  
♥ JT98  
♦ KT987  
♣ K4  
*Dummy*



# U3A Intermediate Bridge 2025-26



## Week 14 Set Hand wk12#3

Dir={S} Vul={EW} 6H by {N}

*{N} makes a plan.*

♠ 32  
 ♥ AK432  
 ♦ AQJ  
 ♣ A32

eXtra Tricks ~

S~ Lose KS→AS, win QS

H~ Ruff 1\*C in {S}

Ruff 2\*D with 2\*L5H in {N}.

That makes 9TT + 4XT = 13 tricks at a **cost** of 1 lost trick. So aim for 12 tricks.

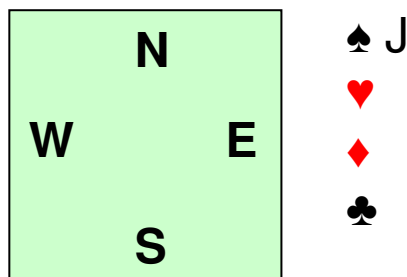

♠ KQ  
 ♥ JT98  
 ♦ KT987  
 ♣ K4  
*Dummy*



# U3A Intermediate Bridge 2025-26



## Week 14 Set Hand wk12#3

Dir={S} Vul={EW} 6H by {N}

♠ 32  
♥ AK432  
♦ AQJ  
♣ A32

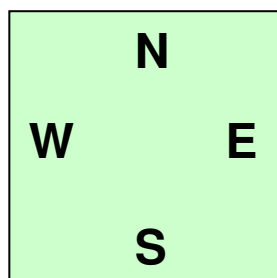

♠ KQ  
♥ JT98  
♦ KT987  
♣ K4  
*Dummy*

♠ J  
♥  
♦  
♣

*{N} makes a plan.*

Worry about Defence ~

{N}'s trumps (H) holding is

H:AK\_JT98\_\_432

just missing H:Q765.

Playing to drop the QH  
under H:AK works just  
over 50% of the time

(53%).

This is ever so slightly  
better than a 50% finesse.

So play for the drop,  
promoting both {S} H:JT if the  
drop works as well as {N}  
H:432.

Entries/Execution ~

There appear to be plenty of  
entries in both directions.



# U3A Intermediate Bridge 2025-26



## Week 14 Set Hand wk12#3

Dir={S} Vul={EW} 6H by {N}

The play:

E1) (JS)...

♠ 32  
 ♥ AK432  
 ♦ AQJ  
 ♣ A32

♠ A54  
 ♥ 76  
 ♦ 6  
 ♣ JT98765

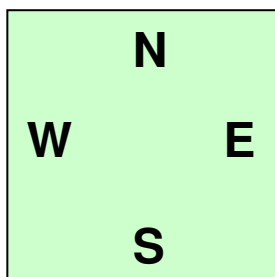

♠ JT9876  
 ♥ Q5  
 ♦ 5432  
 ♣ Q

♠ KQ  
 ♥ JT98  
 ♦ KT987  
 ♣ K4

*Dummy*



# U3A Intermediate Bridge 2025-26



## Week 14 Set Hand wk12#3

Dir={S} Vul={EW} 6H by {N}

The play:

E1) (JS)→QS→(AS) ↓

♠ 32  
 ♥ AK432  
 ♦ AQJ  
 ♣ A32

♠ A54  
 ♥ 76  
 ♦ 6  
 ♣ JT98765

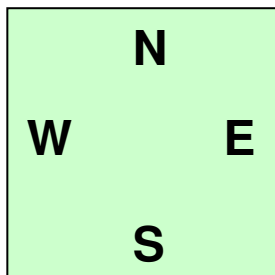

♠ JT9876  
 ♥ Q5  
 ♦ 5432  
 ♣ Q

♠ KQ  
 ♥ JT98  
 ♦ KT987  
 ♣ K4  
*Dummy*



# U3A Intermediate Bridge 2025-26



## Week 14 Set Hand wk12#3

Dir={S} Vul={EW} 6H by {N}

The play:

E1) (JS)→QS→(AS)      ↓  
W2) (5S)→KS              (1)

♠ 2  
♥ AK432  
♦ AQJ  
♣ A32

♠ 54  
♥ 76  
♦ 6  
♣ JT98765

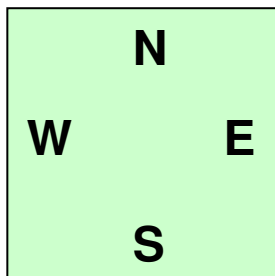

♠ T9876  
♥ Q5  
♦ 5432  
♣ Q

♠ K  
♥ JT98  
♦ KT987  
♣ K4  
*Dummy*



# U3A Intermediate Bridge 2025-26



## Week 14 Set Hand wk12#3

Dir={S} Vul={EW} 6H by {N}

The play:

♠ \_\_\_  
 ♥ AK432  
 ♦ AQJ  
 ♣ A32

E1) (JS)→QS→(AS)      ↓  
 W2) (5S)→KS              (1)  
 S3) Draw trumps  
      8H→AH                  (2)

♠ \_\_\_4  
 ♥ 76  
 ♦ 6  
 ♣ JT98765

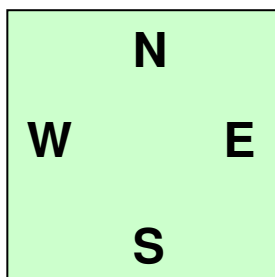

♠ \_\_\_9876  
 ♥ Q5  
 ♦ 5432  
 ♣ Q

♠ \_\_\_  
 ♥ JT98  
 ♦ KT987  
 ♣ K4  
*Dummy*



# U3A Intermediate Bridge 2025-26



## Week 14 Set Hand wk12#3

Dir={S} Vul={EW} 6H by {N}

♠ \_\_\_  
 ♥ K432  
 ♦ AQJ  
 ♣ A32

♠ \_\_\_4  
 ♥ 6  
 ♦ 6  
 ♣ JT98765

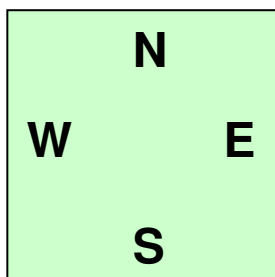

♠ \_\_\_9876  
 ♥ Q  
 ♦ 5432  
 ♣ Q

♠ \_\_\_  
 ♥ JT9\_  
 ♦ KT987  
 ♣ K4  
*Dummy*

The play:

- E1) (JS)→QS→(AS)            ↓
  - W2) (5S)→KS                    (1)
  - S3) Draw trumps.                8H→AH                    (2)
  - N4) Will QH drop...            KH→(QH)                (3)
- All trumps drawn.



# U3A Intermediate Bridge 2025-26



## Week 14 Set Hand wk12#3

Dir={S} Vul={EW} 6H by {N}

♠ \_\_\_  
 ♥ \_\_\_432  
 ♦ **AQJ**  
 ♣ A32

♠ \_\_\_4  
 ♥ \_\_\_  
 ♦ **6**  
 ♣ JT987**65**

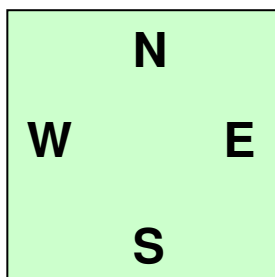

♠ \_\_\_9876  
 ♥ \_\_\_  
 ♦ **5432**  
 ♣ Q

♠ \_\_\_  
 ♥ JT\_\_\_  
 ♦ **KT987**  
 ♣ K4  
*Dummy*

The play:

- E1) (JS)→QS→(AS)            ↓
- W2) (5S)→KS                    (1)
- S3) Draw trumps.                (2)
- 8H→AH
- N4) Will QH drop...            (3)
- KH→(QH)
- All trumps drawn.
- Now just take winners.
- N5) AD                            (4)
- N6) QD                            (5)
- N7) JD                            (6)



# U3A Intermediate Bridge 2025-26



## Week 14 Set Hand wk12#3

Dir={S} Vul={EW} 6H by {N}

♠ \_\_\_  
 ♥ \_\_\_432  
 ♦ \_\_\_  
 ♣ A32

♠ \_\_\_4  
 ♥ \_\_\_  
 ♦ \_\_\_  
 ♣ JT987\_\_\_

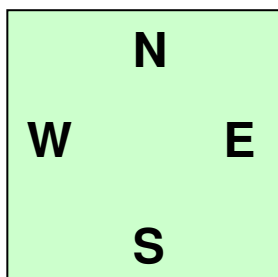

♠ \_\_\_9876  
 ♥ \_\_\_  
 ♦ 5\_\_\_  
 ♣ Q

♠ \_\_\_  
 ♥ JT\_\_\_  
 ♦ KT\_\_\_  
 ♣ K4  
*Dummy*

The play:

- E1) (JS)→QS→(AS) ↓
- W2) (5S)→KS (1)
- S3) Draw trumps. (2)  
8H→AH
- N4) Will QH drop... (3)  
KH→(QH)  
All trumps drawn.
- Now just take winners.
- N5) AD (4)
- N6) QD (5)
- N7) JD (6)
- Crossover to KC and win:
- N8) 2C→KC (7)
- S9,10) KD, 10D (8,9)
- S11,12) JH, 10H (10,11)
- S13) 4C→4H (12)



# U3A Intermediate Bridge 2025-26



## Week 14 Set Hand wk12#3

Dir={S} Vul={EW} 6H by {N}

The result:

6H✓ by {N}

6 \* 30 = 180

Game = 300

Small Slam = 500

Total = 980

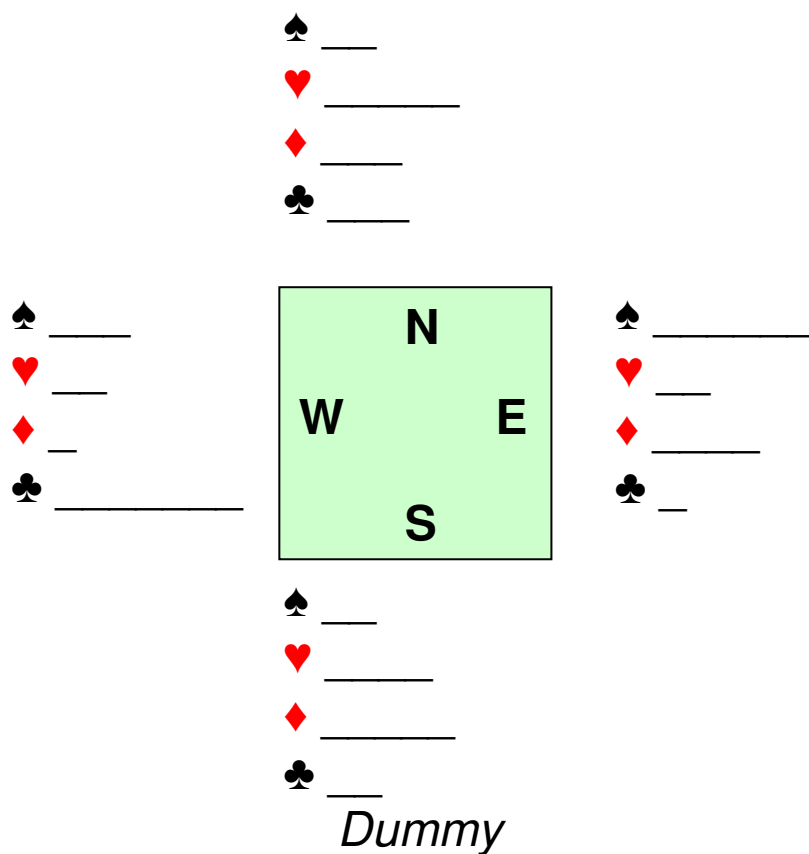



# U3A Intermediate Bridge 2023-24



## Week 14 Set hands

The second set hand analysis was omitted from the presentation - we ran out of time. It is included here, because "why not".



# U3A Intermediate Bridge 2023-24



## Week 14 Set Hand wk13#2

This week we are reviewing a couple of set hands from previous weeks.

The second is set hand 2 from week 13.

I talked two tables through the auction at the time, but I think it bears repeating.

Board=3

Dealer={S}

Vulnerability={EW}

NS	EW	Contract	Dcl	OL	Trk	NS#	EW#	NS%	EW%
2	10	3H+2	W	8S	11	-	200	100%	0%
1	9	6H=	W	AD	12	-	980	50%	50%
4	12	6H=	W	JS	12	-	980	50%	50%
Ref A		6H=	W	AD	12	-	980	50%	50%
Ref B		6H+1	W	JS	13	-	1010	0%	100%

This is an obvious instance of the opening lead making a difference to the reference result. The AD only makes if played before 5D is discarded. The source recommends an opening lead of JS. The unsupported AD is not a bookish lead, but works well here.

I describe the play as illustrated in the source material.

Again we will be reviewing the auction, the opening lead and the play.



# U3A Intermediate Bridge 2025-26



## Week 14 Set Hand wk13#2

Dir={E} Vul={NS}

<b>E</b>	<b>S</b>	<b>W</b>	<b>N</b>
?			

This is the whole deal.

As we discuss the auction, I will select just the hand making a bid.

{E} is dealer.

What do we do first?

♠ JT98  
 ♥ T98  
 ♦ AJ984  
 ♣ T

♠ AK63  
 ♥ AJ763  
 ♦ 5  
 ♣ QJ7

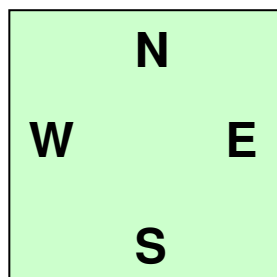

♠ 2  
 ♥ KQ52  
 ♦ 763  
 ♣ AK543

♠ Q754  
 ♥ 4  
 ♦ KQT2  
 ♣ 9862



# U3A Intermediate Bridge 2025-26



## Week 14 Set Hand wk13#2

Dir={E} Vul={NS}

<b>E</b>	<b>S</b>	<b>W</b>	<b>N</b>
?			

We evaluate {E}'s hand.

5431 shape (L5C is a minor, so {E} is more interested in NT or in L4H than his L5C).

hcp = KQAK = 12hcp.

And next?

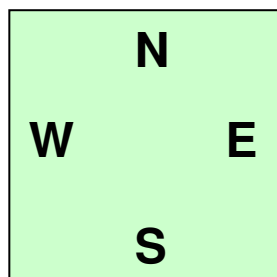

♠ 2  
 ♥ KQ52  
 ♦ 763  
 ♣ AK543

5431
12hcp





# U3A Intermediate Bridge 2025-26



## Week 14 Set Hand wk13#2

Dir={E} Vul={NS}

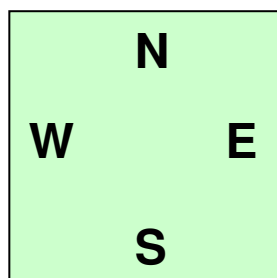

♠ 2  
 ♥ KQ52  
 ♦ 763  
 ♣ AK543

5431  
 12hcp  
 13Pts

1+1;

**E**      **S**      **W**      **N**  
 ?

And next we evaluate more fully using "hltf aiu(s)".

hcp	12
length	+1(L5C, to A)
tens	0(N/A)
flat	0(N/A)
acelessness	0(AC)
isolated	0(None)
unguarded	0(N/A)
(shortage)	<i>Not yet</i>

12+1 = 13Pts.  
 Is that enough to open the bidding? Yes. So {E} bids...



# U3A Intermediate Bridge 2025-26



## Week 14 Set Hand wk13#2

Dir={E} Vul={NS}

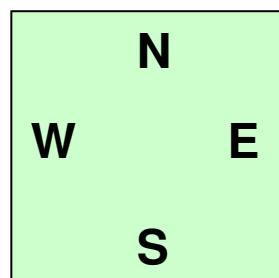

♠ 2  
 ♥ KQ52  
 ♦ 763  
 ♣ AK543

5431
12hcp
13Pts

l+1;

E	S	W	N
1C			

So {E} bids one of their longest suit, C. The bid shows  
 12..19..22Pts, L4+C.

Note the unusual range is more than the normal 12..19. This is because a 2C opening bid is the "superstrong" 23+ bid and there is no "20..22Pts" opening bid in basic Acol. Thus 1C has to take on that duty as well.

{S} actually has  
 (12hcp, 13Pts, L5C.)



# U3A Intermediate Bridge 2023-24



## Week 14 Aside

Note that in this presentation we are doing the evaluations for all four hands.

In actual play, you only do the evaluation for just one hand, your own, so it isn't anywhere near the mammoth task that this presentation makes it seem.



# U3A Intermediate Bridge 2025-26



Week 14 Set Hand wk13#2

Dir={E} Vul={NS}

<b>E</b>	<b>S</b>	<b>W</b>	<b>N</b>
1C	?		
Evaluate {S} ...			

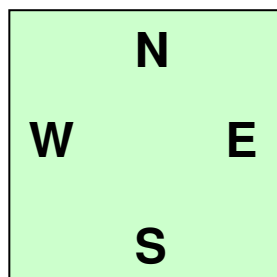

- ♠ Q754
- ♥ 4
- ♦ KQT2
- ♣ 9862



# U3A Intermediate Bridge 2025-26



## Week 14 Set Hand wk13#2

Dir={E} Vul={NS}

<b>E</b>	<b>S</b>	<b>W</b>	<b>N</b>
1C	?		

4441 shape.

hcp = QKQ = 7hcp.

Next a fuller evaluation...

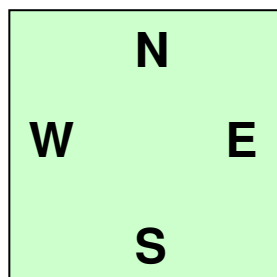

4441
7hcp

♠ Q754  
 ♥ 4  
 ♦ KQT2  
 ♣ 9862





# U3A Intermediate Bridge 2025-26



## Week 14 Set Hand wk13#2

Dir={E} Vul={NS}

<b>E</b>	<b>S</b>	<b>W</b>	<b>N</b>
1C	P		

4441 shape.

hcp = QKQ = 7hcp.

Next a fuller evaluation using "hltf aiu(s)".

hcp	7
length	0(No L5+suit)
tens	+1/2(10D)
flat	0(N/A)
acelessness	-1(No A)
isolated	0(Only 1, QS)
unguarded (shortage)	0(N/A) <i>Not yet</i>

$7 + \frac{1}{2} - 1 = 6\frac{1}{2}$ Pts.

*No overcall, no TOD, so Pass.*

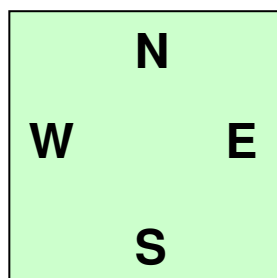

4441
7hcp
6½Pts

♠ Q754  
♥ 4  
♦ KQT2  
♣ 9862

t+1/2;  
a-1;



# U3A Intermediate Bridge 2025-26



Week 14 Set Hand wk13#2

Dir={E} Vul={NS}

<b>E</b>	<b>S</b>	<b>W</b>	<b>N</b>
1C	P	?	

Evaluate {W} ...

♠ AK63  
♥ AJ763  
♦ 5  
♣ QJ7

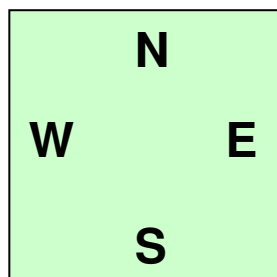



# U3A Intermediate Bridge 2025-26



## Week 14 Set Hand wk13#2

Dir={E} Vul={NS}

5431  
15hcp

♠ AK63  
♥ AJ763  
♦ 5  
♣ QJ7

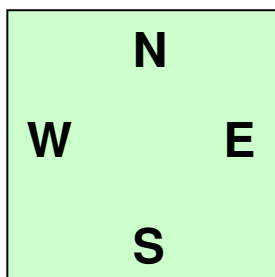

<b>E</b>	<b>S</b>	<b>W</b>	<b>N</b>
1C	P	?	

5431 shape.

hcp = AKAJQJ = 15hcp.

Next a fuller evaluation using "hltf aiu(s)".

hcp 15

length

tens

flat

acelessness

isolated

unguarded

(shortage)



# U3A Intermediate Bridge 2025-26



## Week 14 Set Hand wk13#2

Dir={E} Vul={NS}

l+1;

5431  
15hcp  
16Pts

♠ AK63  
♥ AJ763  
♦ 5  
♣ QJ7

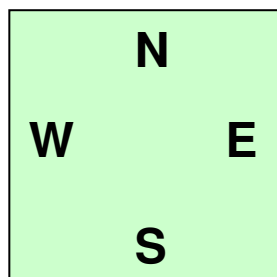

<b>E</b>	<b>S</b>	<b>W</b>	<b>N</b>
1C	P	?	

5431 shape.

hcp = AKAJQJ = 15hcp.

Next a fuller evaluation using "hltf aiu(s)".

hcp	15
length	+1(L5H,A)
tens	0(N/A)
flat	0(N/A)
acelessness	0(AS,AH)
isolated	0(None)
unguarded	0(N/A)
(shortage)	<i>Not yet</i>

15+1 = 16Pts.

*So what to bid?*



# U3A Intermediate Bridge 2025-26



## Week 14 Set Hand wk13#2

Dir={E} Vul={NS}

l+1;

5431  
15hcp  
16Pts

♠ AK63  
♥ AJ763  
♦ 5  
♣ QJ7

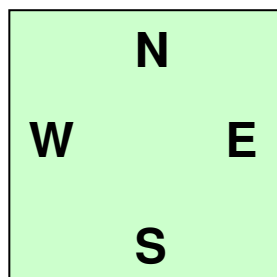

<b>E</b>	<b>S</b>	<b>W</b>	<b>N</b>
1C	P	1H	

5431 shape.

hcp = AKAJQJ = 15hcp.

16Pts.

Respond with 1LongestSuit = 1H.

1H shows 6+Pts, L4+H.

A reminder:

1X (-) 1Y shows 6+Pts, L4+Y

1X (-) 2Y *no jump* shows 10+Pts, L4+Y



# U3A Intermediate Bridge 2023-24



## Week 14 Aside

It isn't relevant for this deal, but last time I had to remind some of you that:

1X (-) 1Y (-)	1X shows 12..19Pts, L4+X
1Z	1Z shows 12..19Pts, L4+Z, L5+X

And I also remind you that

1X (-) 1Y (-)	1X shows 12..19Pts, L4+X
2Z	2Z shows 12..19Pts if not a reverse, L4+Z, L5+X
	2Z shows 16..19Pts if a reverse, L4+Z, L5+X



# U3A Intermediate Bridge 2025-26



## Week 14 Set Hand wk13#2

Dir={E} Vul={NS}

<b>E</b>	<b>S</b>	<b>W</b>	<b>N</b>
1C	P	1H	?

Evaluate {N} ...

- ♠ JT98
- ♥ T98
- ♦ AJ984
- ♣ T

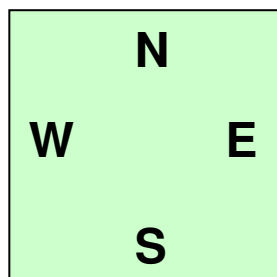





# U3A Intermediate Bridge 2025-26



## Week 14 Set Hand wk13#2

Dir={E} Vul={NS}

♠ JT98	5431	l+1;
♥ T98	6hcp	t+1;
♦ AJ984	8Pts	
♣ T		

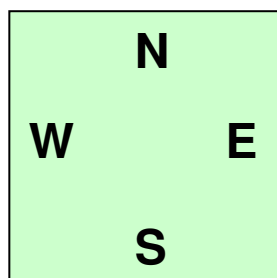

Too weak to overcall with 2D.  
 Too weak for a TOD after 1C.  
 So Pass.

<b>E</b>	<b>S</b>	<b>W</b>	<b>N</b>
1C	P	1H	P

5431 shape.  
 hcp = JAJ = 6hcp.

Next a fuller evaluation using "hltf aiu(s)".

hcp	6
length	+1(L5D,A)
tens	+1(10S,10H)
flat	0(N/A)
acelessness	0(AD)
isolated	0(One,10H)
unguarded	0(N/A)
(shortage)	<i>Not yet</i>

6+1+1 = 8Pts



# U3A Intermediate Bridge 2025-26



## Week 14 Set Hand wk13#2

Dir={E} Vul={NS}

<b>E</b>	<b>S</b>	<b>W</b>	<b>N</b>
1C	P	1H	P
?			

Ah! {E} now knows of a H fit:  
L4+H + L4H = 8+ \* H fit.

Re-eval:

13Pts + 3Pts(L1S,135)  
= 16Pts.

*The H suit is "owned" by {W},  
who bid it first.*

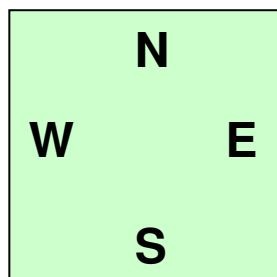

♠ 2  
♥ KQ52  
♦ 763  
♣ AK543

5431
12hcp
16Pts

l+1; s+3;



# U3A Intermediate Bridge 2025-26



## Week 14 Set Hand wk13#2

Dir={E} Vul={NS}

<b>E</b>	<b>S</b>	<b>W</b>	<b>N</b>
1C	P	1H	P
?			

Jointly:

$$16\text{Pts} + 6\text{+Pts} = 22\text{+ JPts.}$$

A rebid of 2H would show a minimum (12Pts) fit. With 16Pts, bid more.

But do not KNOW of 25+Pts, so shouldn't bid Game (#4H).

Therefore bid #3H invitational.

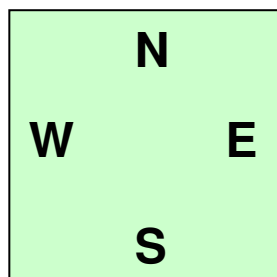

♠ 2  
 ♥ KQ52  
 ♦ 763  
 ♣ AK543

5431
12hcp
16Pts

l+1; s+3;

*Sometimes #3H is invitational, sometimes it is strong suggesting a slam. Decide which with context and further bidding...*



# U3A Intermediate Bridge 2025-26



## Week 14 Set Hand wk13#2

Dir={E} Vul={NS}

<b>E</b>	<b>S</b>	<b>W</b>	<b>N</b>
1C	P	1H	P
#3H			

But we now have another tool in our arsenal. The Losing Trick Count. There is an 8+card H fit, so we can use the LTC here.

LTs: 1S,1H,3D,1C = 6LTs.

Assuming {W}, responder, has 9LTs, the LTC suggests  $18 - 9\text{LTs} - 6\text{LTs} = 3$ . Bid **#3H**.

The LTC is suggesting the same bid as the point count system.

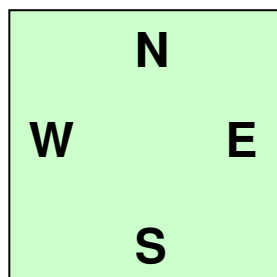

♠ 2  
 ♥ KQ52  
 ♦ 763  
 ♣ AK543

5431
12hcp
<b>16Pts</b>

l+1; **s+3**;

The minimum response showing a H fit is 2S. 6LTs is 1 better than 7LTs, so bid 1 more than 2S: **#3H**.



# U3A Intermediate Bridge 2025-26



## Week 14 Set Hand wk13#2

Dir={E} Vul={NS}

<b>E</b>	<b>S</b>	<b>W</b>	<b>N</b>
1C	P	1H	P
#3H	P		

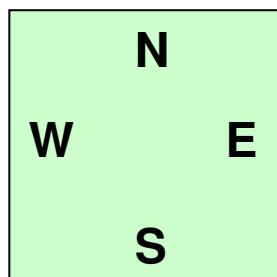

4441
7hcp
6½Pts

♠ Q754  
 ♥ 4  
 ♦ KQT2  
 ♣ 9862

t+½;  
 a-1;



# U3A Intermediate Bridge 2025-26



## Week 14 Set Hand wk13#2

Dir={E} Vul={NS}

<b>E</b>	<b>S</b>	<b>W</b>	<b>N</b>
1C	P	1H	P
#3H	P	?	

l+1;

5431
15hcp
16Pts

♠ AK63  
 ♥ AJ763  
 ♦ 5  
 ♣ QJ7

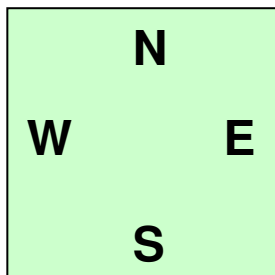

What does {W} do now?



# U3A Intermediate Bridge 2025-26



## Week 14 Set Hand wk13#2

Dir={E} Vul={NS}

l+1; s+2;

5431  
15hcp  
18Pts

♠ AK63  
♥ AJ763  
♦ 5  
♣ QJ7

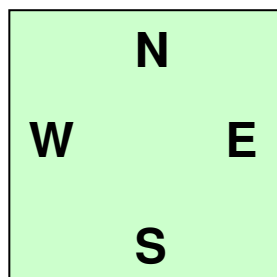

<b>E</b>	<b>S</b>	<b>W</b>	<b>N</b>
1C	P	1H	P
#3H	P	?	

What does {W} do now?

{W} realises that {EW} have an 9+ card fit and re-evaluates his hand.

16Pts + 2Pts(L1D,123) = 18Pts.  
*(It is {W}'s H suit, he bid it first.)*

Jointly they have  
18Pts + 16+Pts = 34+Pts and  
9+ cards in Hs. So a slam is  
worth investigating.



# U3A Intermediate Bridge 2025-26



## Week 14 Set Hand wk13#2

Dir={E} Vul={NS}

l+1; s+2;

5431  
15hcp  
18Pts

♠ AK63  
♥ AJ763  
♦ 5  
♣ QJ7

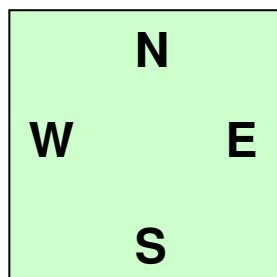

<b>E</b>	<b>S</b>	<b>W</b>	<b>N</b>
1C	P	1H	P
#3H	P	?	

What does {W} do now?

{W} also can use the LTC.

LTs: 1S,2H,1D,2C = 6LTs.

*(The QC being supported by JC.)*

{E} didn't bid 2H which would suggest 7LT as opener, but jumped to #3H suggesting 6LTs.

18-6-6 = 6. Suggesting a #6H small slam is on.

Therefore investigate a slam.



# U3A Intermediate Bridge 2025-26



## Week 14 Set Hand wk13#2

Dir={E} Vul={NS}

l+1; s+2;

5431  
15hcp  
18Pts

♠ AK63  
♥ AJ763  
♦ 5  
♣ QJ7

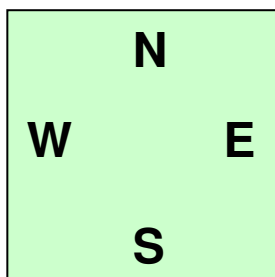

{W} bids the first suit up from 3H that he, {W}, has controlled. That suit is S, so he bids **3S**.

<b>E</b>	<b>S</b>	<b>W</b>	<b>N</b>
1C	P	1H	P
#3H	P	3S	

Before bidding #6H, {W} wants to check that the slam suggestion is viable.

Do the partnership have control (first or second round) of each suit. First round is Ace or void (ruff), second round is King or Singleton (delayed ruff).

S: A  
H: A  
D: L1D  
C: Q which is not a control.

So {W} uses an Italian Cue Bid to discover if {E} has a C control.



# U3A Intermediate Bridge 2025-26



## Week 14 Set Hand wk13#2

Dir={E} Vul={NS}

♠ JT98	5431	l+1;
♥ T98	6hcp	t+1;
♦ AJ984	8Pts	
♣ T		

E	S	W	N
1C	P	1H	P
#3H	P	3S	P
{N} passes.			

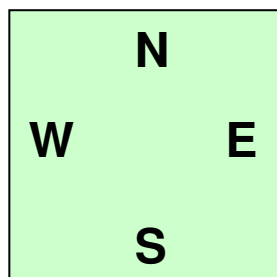



# U3A Intermediate Bridge 2025-26



## Week 14 Set Hand wk13#2

Dir={E} Vul={NS}

<b>E</b>	<b>S</b>	<b>W</b>	<b>N</b>
1C	P	1H	P
#3H	P	3S	P
?			

What does {E} do?

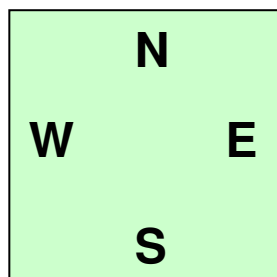

♠ 2  
 ♥ KQ52  
 ♦ 763  
 ♣ AK543

5431  
 12hcp  
 16Pts

l+1; s+3;



# U3A Intermediate Bridge 2025-26



## Week 14 Set Hand wk13#2

Dir={E} Vul={NS}

E	S	W	N
1C	P	1H	P
#3H	P	3S	P
4C			

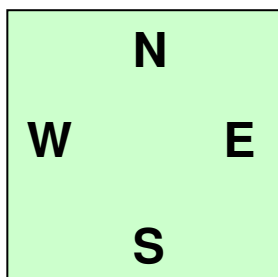

♠ 2  
 ♥ KQ52  
 ♦ 763  
 ♣ AK543

5431  
 12hcp  
 16Pts

l+1; s+3;

It is important to bid the suits in order up the ranking. The last bid was S. Next is C. {E} has C control, so bids 4C.

{E} intended his #3H bid as invitational. But {EW} have explicitly found a H fit, both having bid the suit. So a new suit is NOT seeking a fit but must mean "something". They play ICB, so it is an Italian Cue Bid showing control in S.

{E} should return in kind. He should bid 4C with C control; 4D without C control but with D control; and 4H with neither C nor D control. He has both S control (L1S) and C control (AC).



# U3A Intermediate Bridge 2025-26



## Week 14 Set Hand wk13#2

Dir={E} Vul={NS}

E	S	W	N
1C	P	1H	P
#3H	P	3S	P
4C	P	?	

{S} passes.

And {N}?

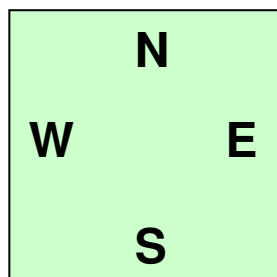

♠ 2  
 ♥ KQ52  
 ♦ 763  
 ♣ AK543

5431  
 12hcp  
 16Pts

l+1; s+3;



# U3A Intermediate Bridge 2025-26



## Week 14 Set Hand wk13#2

Dir={E} Vul={NS}

l+1; s+2;

5431  
15hcp  
18Pts

♠ AK63  
♥ AJ763  
♦ 5  
♣ QJ7

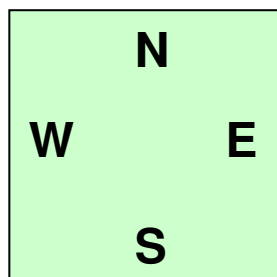

So {W} initiates **Keycard Blackwood** by asking the question with **4NT**, to which he has already decided how to answer any reply.

E	S	W	N
1C	P	1H	P
#3H	P	3S	P
4C	P	4NT	

{W} now knows that all four suits are controlled. So He needs to determine how many are first round control using **Keycard Blackwood** (the same as basic **Blackwood**, but also counts the King of Trumps, here KH).

{W} has 2 keycards (AS AH) and is missing 3 (AD AC KH).

If {E} has 3 will investigate 7H.  
If {E} has 2 will bid 6H.  
If {E} has 1- will bail out to 5H.



# U3A Intermediate Bridge 2025-26



## Week 14 Set Hand wk13#2

Dir={E} Vul={NS}

E	S	W	N
1C	P	1H	P
#3H	P	3S	P
4C	P	4NT	P
?			

{N} passes.

How does {S} reply?

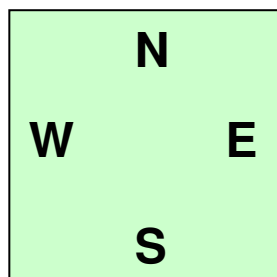

♠ 2  
 ♥ KQ52  
 ♦ 763  
 ♣ AK543

5431  
 12hcp  
 16Pts

l+1; s+3;



# U3A Intermediate Bridge 2025-26



## Week 14 Set Hand wk13#2

Dir={E} Vul={NS}

E	S	W	N
1C	P	1H	P
#3H	P	3S	P
4C	P	4NT	P
5H			

How does {S} reply?

{S} has 2 Keycards: AC KH.

5C is 0 or 4;

5D is 1 (or 5 - unlikely);

5H is 2;

5S is 3.

So {E}, with 2, bids **5H**.

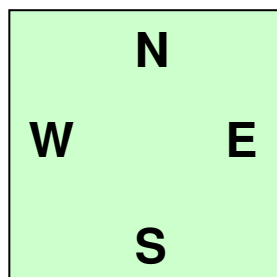

♠ 2  
 ♥ KQ52  
 ♦ 763  
 ♣ AK543

5431  
 12hcp  
 16Pts

l+1; s+3;



# U3A Intermediate Bridge 2025-26



## Week 14 Set Hand wk13#2

Dir={E} Vul={NS}

l+1; s+2;

5431  
15hcp  
18Pts

♠ AK63  
♥ AJ763  
♦ 5  
♣ QJ7

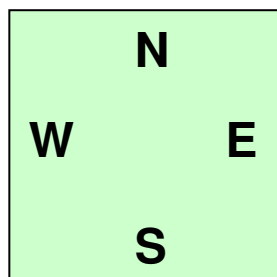

E	S	W	N
1C	P	1H	P
#3H	P	3S	P
4C	P	4NT	P
5H	P	6H	P
P	P		

{S} passes.

{W} with prepared next bids hears "2 Keycards" (5H), so as {EW}, they are only missing one Keycard. Therefore {W} bids 6H, after which everyone passes.

*The play is interesting.*



# U3A Intermediate Bridge 2025-26



## Week 14 Set Hand wk13#2

Dir={E} Vul={NS} 6H by {W}

♠ JT98  
 ♥ T98  
 ♦ AJ984  
 ♣ T

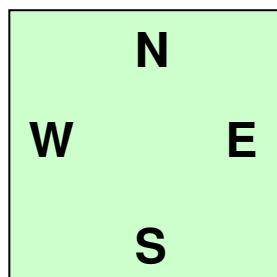

The opening lead is of course made face down, accompanied by the query "**Any questions** (about the auction) **partner?**". Then turn the card face up.

E	S	W	N
1C	P	1H	P
#3H	P	3S	P
4C	P	4NT	P
5H	P	6H	P
P	P		

{N} makes the opening lead.

Good **bookish** leads against a suit contract (including slam suit contracts) are:

- Singleton (*allows ruffing*)
- Top of honour headed sequences of 2+. (*Thus **AK**, **KQ**, **QJ**, **JT** and even **T9**.*)
- Lowest trump if ruffing expected.



# U3A Intermediate Bridge 2025-26



## Week 14 Set Hand wk13#2

Dir={E} Vul={NS} 6H by {W}

♠ JT98  
 ♥ T98  
 ♦ AJ984  
 ♣ T

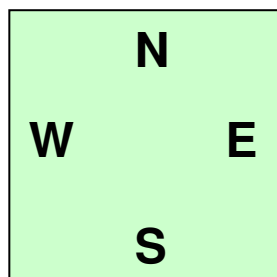

- a), b) and c) work out the same.
- d) proves better in practice.

E	S	W	N
1C	P	1H	P
#3H	P	3S	P
4C	P	4NT	P
5H	P	6H	P
P	P		

So plausible leads include:

- a) suggests 10C
- b) with S:JT98 suggests JS
- c) 8H

And not bookish at all, one U3AIB {N} led AD.



# U3A Intermediate Bridge 2025-26



## Week 14 Set Hand wk13#2

Dir={E} Vul={NS} 6H by {W}

♠ J  
♥ 8  
♦ A  
♣ T

♠ AK63  
♥ AJ763  
♦ 5  
♣ QJ7

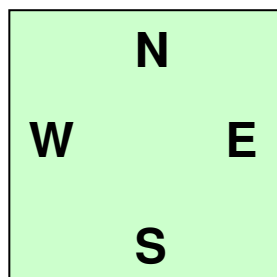

♠ 2  
♥ KQ52  
♦ 763  
♣ AK543  
*Dummy*

Plausible leads include:

10C JS 8H and AD.

Dummy is placed on the table in descending order, with trumps (H) on {E}'s right and the other 3 suits in the order preferred by {W}.

{W} makes a plan with ATTITWDE.

- A ~ Aim
- TT ~ Top Tricks
- IT ~ Increase Tricks  
(I use XT eXtra Tricks)
- WD ~ Worry about Defence
- E ~ Entries and Execution



# U3A Intermediate Bridge 2025-26



## Week 14 Set Hand wk13#2

Dir={E} Vul={NS} 6H by {W}

♠ J  
♥ 8  
♦ A  
♣ T

♠ AK63  
♥ AJ763  
♦ 5  
♣ QJ7

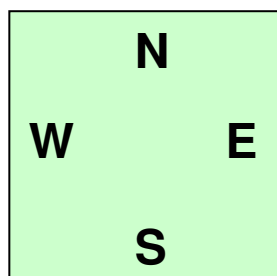

♠ 2  
♥ KQ52  
♦ 763  
♣ AK543  
*Dummy*

Ruffing in the long trump hand doesn't gain tricks. Instead of L5H making 5 H tricks, it may make 3 H tricks and ruff 2 of another suit. But that is still just 5 tricks.

Ruffing in short trump hand does gain tricks. Eg {W} 5\*H + {E} 2\*ruff = 7 tricks.

In Duplicate Pairs, the Aim is to maximise the score. Take some risks to gain overtricks.

Aim ~ Contract+; 12..13 tricks.

Top Tricks ~

S:AK

H:AKQJ

D:-

C:AKQJ = 10 TT.

eXtra Tricks ~ Need 2+XT.

Presume 5<sup>th</sup> H in {W} will win.

[1]

Ruff 2\*S in {E}. [2]

Total = 10TT + 2/3XT = 12..13.



# U3A Intermediate Bridge 2025-26



## Week 14 Set Hand wk13#2

Dir={E} Vul={NS} 6H by {W}

♠ J  
♥ 8  
♦ A  
♣ T

♠ AK63  
♥ AJ763  
♦ 5  
♣ QJ7

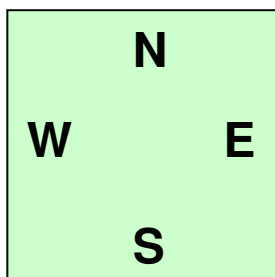

♠ 2  
♥ KQ52  
♦ 763  
♣ AK543  
*Dummy*

To ruff two spades, {W} needs to play one round of S to draw {E}'s 2S under the AS, thus voiding {E}.

{E} also needs to have 2 surplus trumps in the {E} hand - nominally H:52. But {E} can use a master (QH?) if enough trumps remain to be drawn by the other masters.

{EW} have 9\*H, missing 4\*H  
H:AKQJ---765-32.

The most likely split is 3:1. If it is 4:0, then after one round of trumps, {W} will know and can replan. If the split is 3:1 or 2:2, then H:AKJ will draw them all, so the QH is available to ruff.



# U3A Intermediate Bridge 2025-26



## Week 14 Set Hand wk13#2

Dir={E} Vul={NS} 6H by {W}

♠ J  
♥ 8  
♦ A  
♣ T

♠ AK63  
♥ AJ763  
♦ 5  
♣ QJ7

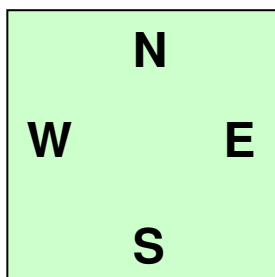

♠ 2  
♥ KQ52  
♦ 763  
♣ AK543  
*Dummy*

There are plenty of Entries into {W} and into {E} hands.

This plan may allow the AD to win a trick regardless of opening lead.

Worry about Defence ~

Apart from the trump split being 4:0, the only worry is the 5D losing to the AD.

This obviously happens if the opening lead is AD, and can happen with a non-ideal plan.

The plan I suggested to two of U3AIB's tables was:

- Win the lead;
- Void {E} of S;
- Lead a low S & ruff it;
- Cross back to {W} (maybe with a trump to draw some of them).
- Lead a low S & ruff it;
- Draw remaining trumps, win TT.



# U3A Intermediate Bridge 2025-26



## Week 14 Set Hand wk13#2

Dir={E} Vul={NS} 6H by {W}

The play (with JS as lead):

N1) (JS)→AS (1)  
{E} void of S now.

♠ JT98  
♥ T98  
♦ AJ984  
♣ T

♠ AK63  
♥ AJ763  
♦ 5  
♣ QJ7

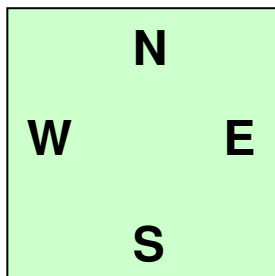

♠ 2  
♥ KQ52  
♦ 763  
♣ AK543  
*Dummy*

♠ Q754  
♥ 4  
♦ KQT2  
♣ 9862



# U3A Intermediate Bridge 2025-26



## Week 14 Set Hand wk13#2

Dir={E} Vul={NS} 6H by {W}

The play (with JS as lead):

♠ \_T98  
♥ T98  
♦ AJ984  
♣ T

N1) (JS)→AS (1)

{E} void of S now.

W2) Ruff a S (2)  
3S→2H

♠ \_K63  
♥ AJ763  
♦ 5  
♣ QJ7

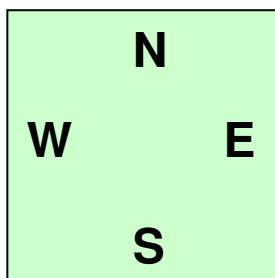

♠ \_  
♥ KQ52  
♦ 763  
♣ AK543  
*Dummy*

♠ Q75\_  
♥ 4  
♦ KQT2  
♣ 9862



# U3A Intermediate Bridge 2025-26



## Week 14 Set Hand wk13#2

Dir={E} Vul={NS} 6H by {W}

♠ \_T9\_  
 ♥ T98  
 ♦ AJ984  
 ♣ T

♠ \_K6\_  
 ♥ AJ763  
 ♦ 5  
 ♣ QJ7

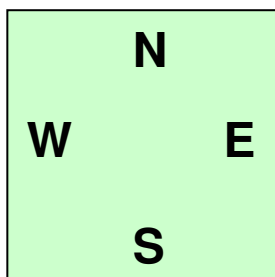

♠ Q7\_\_  
 ♥ 4  
 ♦ KQT2  
 ♣ 9862

♠ \_  
 ♥ KQ5\_  
 ♦ 763  
 ♣ AK543  
*Dummy*

The play (with JS as lead):

- N1) (JS)→AS (1)  
 {E} void of S now.
- W2) Ruff a S  
 3S→2H (2)
- E3) Cross-over drawing trumps  
 5H→JH (keeping AH) (3)  
 3:1 or 2:2 split, 2\*H still out.



# U3A Intermediate Bridge 2025-26



## Week 14 Set Hand wk13#2

Dir={E} Vul={NS} 6H by {W}

♠ T9\_

♥ T9\_

♦ AJ984

♣ T

♠ K6\_

♥ A\_763

♦ 5

♣ QJ7

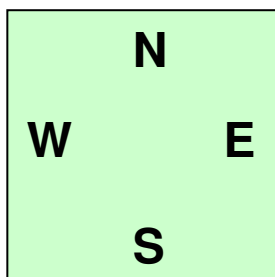

♠ \_

♥ KQ\_

♦ 763

♣ AK543

*Dummy*

♠ Q7\_

♥ \_

♦ KQT2

♣ 9862

The play (with JS as lead):

- N1) (JS)→AS (1)  
    {E} void of S now.
- W2) Ruff a S (2)  
    3S→2H
- E3) Cross-over drawing trumps (3)  
    5H→JH (keeping AH)  
    3:1 or 2:2 split, 2\*H still out.
- W4) Ruff second S (4)  
    6S→QH (master ruff)



# U3A Intermediate Bridge 2025-26



## Week 14 Set Hand wk13#2

Dir={E} Vul={NS} 6H by {W}

♠ \_\_9\_\_  
 ♥ T9\_\_  
 ♦ AJ984  
 ♣ T

♠ \_K\_\_  
 ♥ A\_763  
 ♦ 5  
 ♣ QJ7

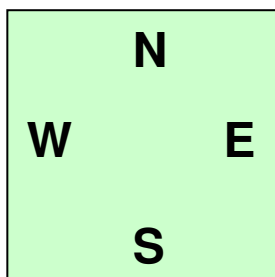

♠ \_\_  
 ♥ K\_\_\_\_  
 ♦ 763  
 ♣ AK543  
*Dummy*

♠ Q\_\_\_\_  
 ♥ \_\_\_\_  
 ♦ KQT2  
 ♣ 9862

The play (with JS as lead):

- N1) (JS)→AS (1)  
 {E} void of S now.
- W2) Ruff a S  
 3S→2H (2)
- E3) Cross-over drawing trumps  
 5H→JH (keeping AH) (3)  
 3:1 or 2:2 split, 2\*H still out.
- W4) Ruff second S  
 6S→QH (master ruff) (4)
- E5) 2\*XT made, draw trumps  
 and take TT.  
 KH (1\*H still out) (5)



# U3A Intermediate Bridge 2025-26



## Week 14 Set Hand wk13#2

Dir={E} Vul={NS} 6H by {W}

♠ 9  
 ♥ 9  
 ♦ AJ984  
 ♣ T

♠ K  
 ♥ A 76  
 ♦ 5  
 ♣ QJ7

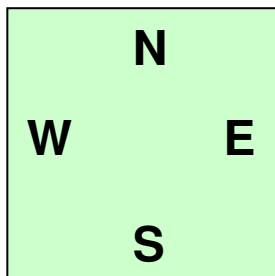

♠ —  
 ♥ —  
 ♦ 763  
 ♣ AK543  
*Dummy*

♠ —  
 ♥ —  
 ♦ KQT2  
 ♣ 9862

The play (with JS as lead):

- N1) (JS)→AS (1)  
 {E} void of S now.
- W2) Ruff a S  
 3S→2H (2)
- E3) Cross-over drawing trumps  
 5H→JH (keeping AH) (3)  
 3:1 or 2:2 split, 2\*H still out.
- W4) Ruff second S  
 6S→QH (master ruff) (4)
- E5) 2\*XT made, draw trumps  
 and take TT.  
 KH (1\*H still out) (5)
- E6) Cross-over to QC  
 3C→QC (6)  
 (Phew, no one was void)



# U3A Intermediate Bridge 2025-26



## Week 14 Set Hand wk13#2

Dir={E} Vul={NS} 6H by {W}

♠ \_\_9\_\_  
 ♥ 9  
 ♦ AJ984  
 ♣ \_\_

♠ \_K\_  
 ♥ A 76\_  
 ♦ 5  
 ♣ \_J7

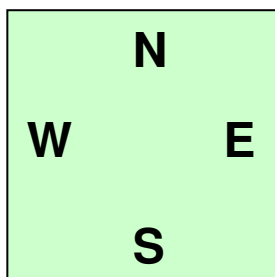

♠ \_\_  
 ♥ \_\_\_\_\_  
 ♦ 763  
 ♣ AK54\_  
*Dummy*

♠ \_\_\_\_\_  
 ♥ \_\_\_\_\_  
 ♦ KQT2  
 ♣ 862

The play (with JS as lead):

- N1) (JS)→AS (1)
- W2) 3S→2H (2)
- E3) 5H→JH (3)
- W4) 6S→QH (4)
- E5) KH (5)
- E6) 3C→QC (6)
- W7) Draw final trump (7)  
AH



# U3A Intermediate Bridge 2025-26



## Week 14 Set Hand wk13#2

Dir={E} Vul={NS} 6H by {W}

♠ 9  
 ♥ \_\_\_\_\_  
 ♦ AJ984  
 ♣ \_\_\_\_\_

♠ K  
 ♥ 76  
 ♦ 5  
 ♣ J7

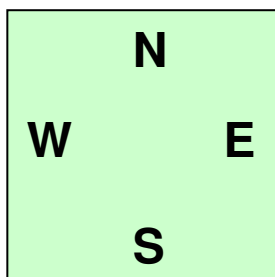

♠ \_\_\_\_\_  
 ♥ \_\_\_\_\_  
 ♦ 76  
 ♣ AK54\_  
*Dummy*

♠ \_\_\_\_\_  
 ♥ \_\_\_\_\_  
 ♦ KQT2  
 ♣ 86

The play (with JS as lead):

- N1) (JS)→AS (1)
- W2) 3S→2H (2)
- E3) 5H→JH (3)
- W4) 6S→QH (4)
- E5) KH (5)
- E6) 3C→QC (6)
- W7) Draw final trump  
AH (7)
- W8..10) Win **KS**, **JC** & **AC**  
(8,9,10)



# U3A Intermediate Bridge 2025-26



## Week 14 Set Hand wk13#2

Dir={E} Vul={NS} 6H by {W}

♠ \_\_\_\_\_  
 ♥ \_\_\_\_\_  
 ♦ **AJ9** \_\_\_\_\_  
 ♣ \_\_\_\_\_

♠ \_\_\_\_\_  
 ♥ \_\_\_\_\_ **76** \_\_\_\_\_  
 ♦ **5** \_\_\_\_\_  
 ♣ \_\_\_\_\_

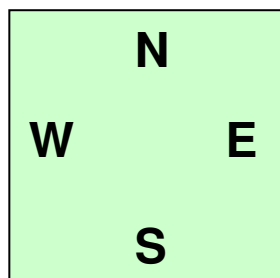

♠ \_\_\_\_\_  
 ♥ \_\_\_\_\_  
 ♦ **7** \_\_\_\_\_  
 ♣ **K5** \_\_\_\_\_  
*Dummy*

♠ \_\_\_\_\_  
 ♥ \_\_\_\_\_  
 ♦ **KQT** \_\_\_\_\_  
 ♣ \_\_\_\_\_

The play (with JS as lead):

N1) (JS)→AS (1)

W2) 3S→2H (2)

E3) 5H→JH (3)

W4) 6S→QH (4)

E5) KH (5)

E6) 3C→QC (6)

W7) Draw final trump  
AH (7)

W8..10) Win KS, JC & AC  
(8,9,10)

E11..13) It was not planned, but this sequence has resulted in the obvious play of discarding losing 5D on KC, thus making an **eXtra eXtra Trick**.

Win **KC**, **7H**, **6H** (11,12,13)



# U3A Intermediate Bridge 2025-26



## Week 14 Set Hand wk13#2

Dir={E} Vul={NS} 6H by {W}

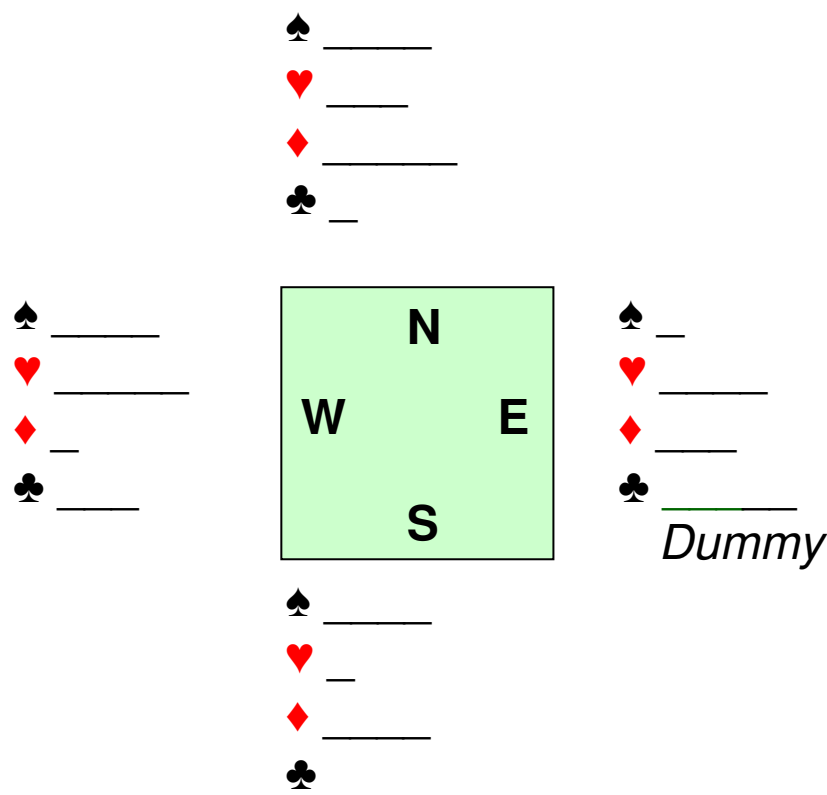

The play (with JS as lead):

- N1) (JS)→AS (1)
- W2) 3S→2H (2)
- E3) 5H→JH (3)
- W4) 6S→QH (4)
- E5) KH (5)
- E6) 3C→QC (6)
- W7) AH (7)
- W8..10) Win KS, JC & AC (8,9,10)
- E11) Win KC, 7H, 6H (11,12,13)

6H+1 by {W}  
 7\*30 = 210  
 Game = 300  
 Slam = 500  
 Total = **1010**



# U3A Intermediate Bridge 2025-26



## Week 14 Play

### Play

**Play as if "Duplicate Pairs".**

{NS} have the pair number of their table, {N} has his back to the stage.  
{EW} have the pair number of their table plus 8.

**Play boards in sequence. Have an incoming pile and an outgoing pile.  
Pass outgoing to next lower numbered table – Table 1 to highest table.**

Some boards have instructions on card. The appropriate people should read each card at the time it says and follow its instructions.

If you play a board twice, record the second play on the traveller using your pair numbers PLUS TEN (eg 1 v 9 becomes 11 v 19).

*If you wish to fill in a personal results card, they are available. They are commonly used at duplicate clubs.*

*Don't forget to describe partner's bids and plays to the table.*

**Any questions? Tea / coffee & biscuit. (25p)**

**PLAY**



# U3A Intermediate Bridge 2025-26



Week 14

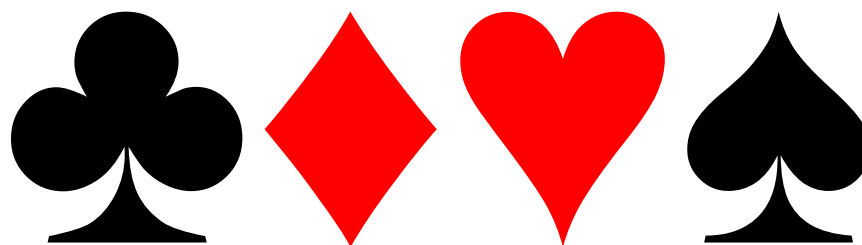

The end

Week 14 set hand  
references follow.



# U3A Intermediate Bridge 2023-24



## Week 14 Set hands

### Set hand sources

SGByyyymmddα Homegrown deals, often wild variants of other deals.

BM:PQ Bernard Magee: Play Quiz

HBSet14 Halifax bridge club set hand examples, set 14.

AR:TfI Andrew Robson: Tips for Intermediates

BM:BSA100 Bernard Magee: Losing Trick Count set hands



# U3A Intermediate Bridge 2023-24



## Week 14 Set hands

### Set hand abbreviations

Dlr	Dealer	(NESW).
Vul	Vulnerability	(None NS EW All).
Rotn	Rotation	Defined by one card, usually A♠. Mostly different to source publication.
Dcl	Declarer	(NESW)
OL	Opening Lead	
Trk	Tricks	(0..13)
NS# EW#		Score for NS or EW
NS% EW%		Percentage of NS and EW
Ref	Reference result	(Sometimes there may be more than one)

Blue results as played.

Red results are reference results.



# U3A Intermediate Bridge 2023-24



## Week 14 Set hands

1 N None SGB20240423a A♠=N

NS	EW	Contract	Dcl	OL	Trk	NS#	EW#	NS%	EW%
Ref		4S=	N	AD	10	420	-	100	0
1	9	3S+1	N	2H	10	170	-	0	100

{N} S:AQ943 H:AQ7 D:542 C:K7

{W} S:2 H:T98 D:QJ86 C:QT52

{E} S:J87 H:K432 D:A973 C:A6

{S} S:KT65 H:J65 D:KT C:J983



# U3A Intermediate Bridge 2023-24



## Week 14 Set hands

2 E NS SGB20260324a A♠=E

NS	EW	Contract	Dcl	OL	Trk	NS#	EW#	NS%	EW%
2	10	5S-3	E	4D	8	150	-	100	0
1	9	4S-1	E	4D	9	50	-	50	50
Ref		6D+1	W	JC	13	940	-	0	100

{N} S:T H:AJ984 D:T98 C:JT98

{W} S:QJ7 H:5 D:AJ763 C:AK63 {E} S:AK543 H:763 D:KQ52 C:2

{S} S:9862 H:KQT2 D:4 C:Q754



# U3A Intermediate Bridge 2023-24



## Week 14 Set hands

3 S EW BM:PQ#0015

A♠=S

NS	EW	Contract	Dcl	OL	Trk	NS#	EW#	NS%	EW%
2	10	3NT+1	S	4S	10	430	-	100	0
Ref		3NT=	S	6S	9	400	-	50	50
1	9	3NT-1	S	6S	8	-	50	0	100



# U3A Intermediate Bridge 2023-24



## Week 14 Set hands

4 W All HBSet14 #14

A♠=W

NS	EW	Contract	Dcl	OL	Trk	NS#	EW#	NS%	EW%
1	9	2S=	E	9H	8	-	110	100	0
2	10	2S+2	E	9H	10	-	170	25	75
Ref		2S+2	E	AC	10	-	170	25	75



# U3A Intermediate Bridge 2023-24



## Week 14 Set hands

5 N NS AR:Tfl #120 A♠=E

NS	EW	Contract	Dcl	OL	Trk	NS#	EW#	NS%	EW%	
3	11	6H=	N	QC	12	1430	-	75	25	<i>Coached</i>
Ref		6H=	N	QC	12	1430	-	75	25	
2	10	4H+1	N	QC	11	650	-	0	100	



# U3A Intermediate Bridge 2023-24



## Week 14 Set hands

6 E EW BM:BSA100 sh#6 A♠=W

NS	EW	Contract	Dcl	OL	Trk	NS#	EW#	NS%	EW%	
3	11	4S=	W	JH	10	-	620	100	0	<i>Coached</i>
Ref		4S+1	W	QH	11	-	650	0	100	



# U3A Intermediate Bridge 2023-24



## Week 14 Set hands

7 S All BM:BSA100 sh#7 A♠=S

NS	EW	Contract	Dcl	OL	Trk	NS#	EW#	NS%	EW%
		<i>Not played</i>							
Ref		4S=	S	3D	10	620	-	50	50



# U3A Intermediate Bridge 2023-24



## Week 14 Set hands

8 W None BM:BSA100 sh#8

A♠=W

NS	EW	Contract	Dcl	OL	Trk	NS#	EW#	NS%	EW%
		<i>Not played</i>							
Ref		6S+1	E	KD	13	-	1010	50	50



# U3A Intermediate Bridge 2025-26



Week 14

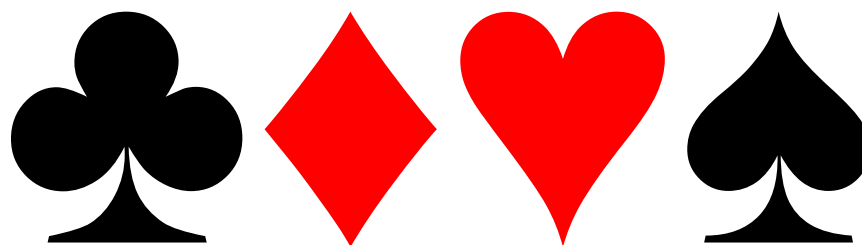

The very end